

**Attachment of Residential Deck
Ledger to End of Metal Plate
Connected Wood Truss Floor Systems**

Installation Instructions

Revised 9/2/2016

SBCA

SBCA has been the voice of the structural building components industry since 1983, providing educational programs and technical information, disseminating industry news, and facilitating networking opportunities for manufacturers of roof trusses, wall panels and floor trusses. **SBCA** endeavors to expand component manufacturers' market share and enhance the professionalism of the component manufacturing industry.

Copyright © 2016 Structural Building Components Association.

Minimum Ledger Requirements

- 2x10 or 2x12 lumber
- Specific gravity > 0.43
- Identified by the grade mark of, or certificate of inspection issued by, an approved lumber grading or inspection bureau or agency.

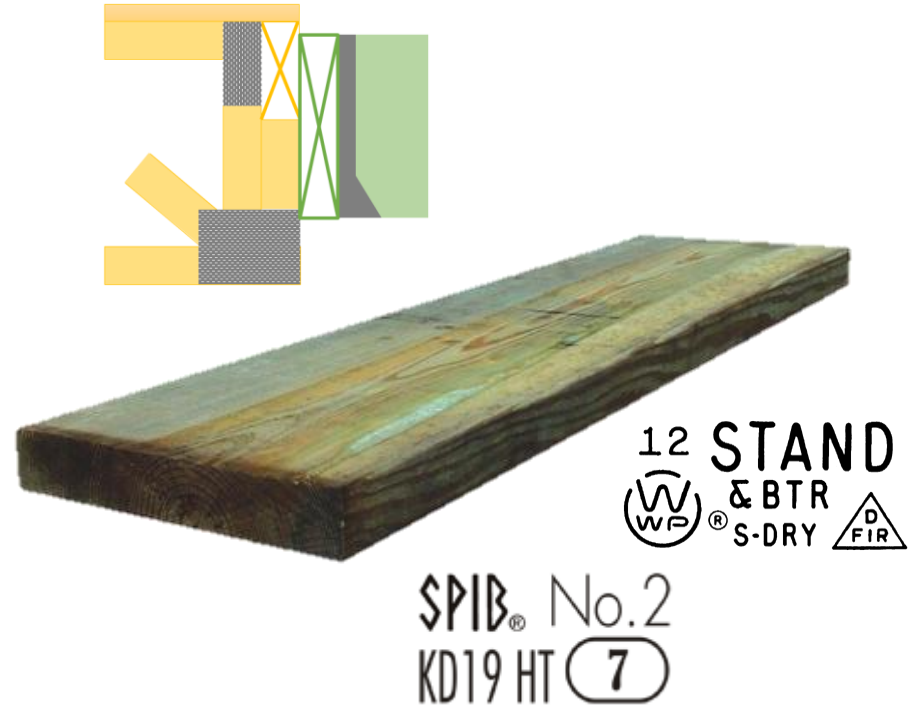

Minimum Ledger Requirements

- Made of PPT (Preservative Pressure Treated) or code approved decay-resistant lumber
- Pressure treatment must be an approved process in accordance with American Wood Protection Association standards.



Step 1: Review Connection Details

- Determine fastener spacing based on the following conditions:
 - Joist span (up to 18')
 - Applicable loading (40 psf or 60 psf)
 - Connection type (end)
 - Fastener type (bolt or lag screw)

Truss Connection Condition and Spacing	Deck Loading	Connection Details	Joist Span						
			≤ to 6'	6'-1" to 8'	8'-1" to 10'	10'-1" to 12'	12'-1" to 14'	14'-1" to 16'	16'-1" to 18'
			On-center Spacing of Fasteners (in.) ⁴						
End Connection / 24" o.c.	Live Load = 40 psf, Dead Load = 10 psf, Snow Load ≤ 40 psf	½" x 6" lag screw with ¹⁵ / ₃₂ " max., wood structural sheathing	24	12 ⁵	12 ⁵	12 ⁵	12 ⁵	8 ⁶	8 ⁶
		½" diameter bolt with ¹⁵ / ₃₂ " max., wood structural sheathing	24	24	24	24	24	12 ⁵	12 ⁵
	Live Load = 60 psf, Dead Load = 10 psf, Snow Load ≤ 60 psf	½" x 6" lag screw with ¹⁵ / ₃₂ " max., wood structural sheathing	12 ⁵	12 ⁵	12 ⁵	8 ⁶	8 ⁶	8 ⁶	Use bolted connection
		½" diameter bolt with ¹⁵ / ₃₂ " max., wood structural sheathing	24	24	24	12 ⁵	12 ⁵	12 ⁵	12 ⁵

1. Ledgers shall be flashed in accordance with applicable building code requirements to prevent water from contacting the exposed wood structural sheathing and floor truss.
 2. Snow load shall not be assumed to act concurrently with live load.
 3. Ledgers must be 2x10 or 2x12 PPT or code-approved decay-resistant lumber with specific gravity, $G \geq 0.43$. Truss 2-ply 2x4 end verticals and key-blocks must have a $G \geq 0.42$.
 4. Stagger lag screws and bolts as shown in [Detail 1](#) for End Connection.
 5. Requires key-blocks at 24" o.c., maximum. Attach ledger to 2-ply end vertical of each truss with one (1) fastener and to each key-block with one (1) fastener. Refer to [Detail 1](#) for key-block construction and installation information.
 6. Requires two (2) key-blocks at 8" o.c., maximum, between each truss. Attach ledger to 2-ply end vertical of each truss with one (1) fastener and to each key-block with one (1) fastener. Refer to [Detail 1](#) for key-block construction and installation information.

Step 1: Review Connection Details

WALL SECTION

NOTE - EXTERIOR CLADDING AND FLASHING NOT SHOWN FOR CLARITY.

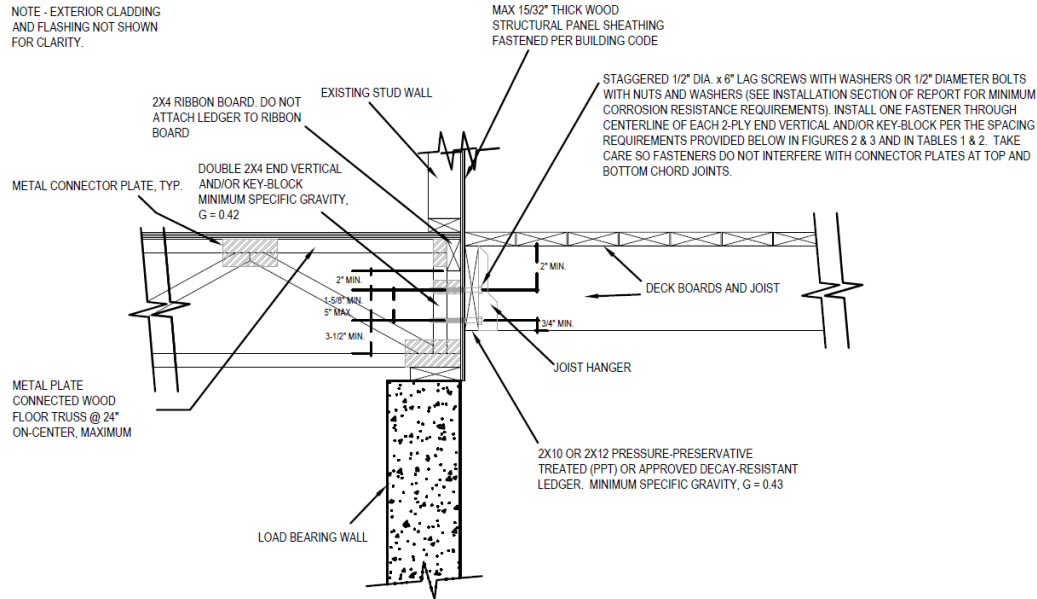

Vertical Load Connection Detail

Step 1: Review Connection Details

LEDGER ATTACHED TO ENDS OF TRUSSES

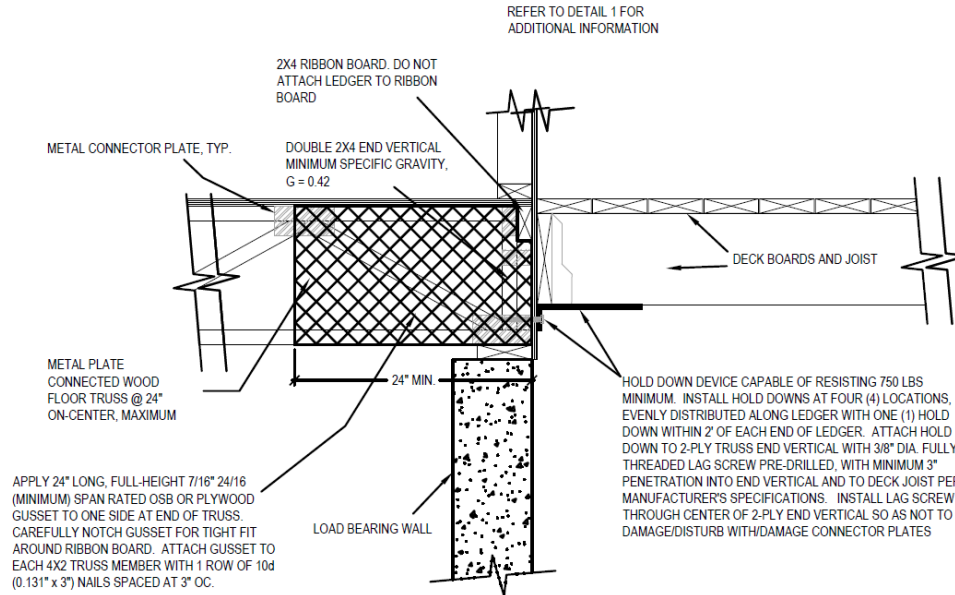

Lateral Load Connection Detail – Ledger Attached at Truss End

Step 2: Install Over Structural Sheathing

- Install ledger directly over wood structural sheathing fastened to the wall per IRC Chapter 6.
- Maximum thickness of sheathing is 15/32"



Step 2: Install Over Structural Sheathing

- Attach ledger through wood structural sheathing into one of the following:
 - 2-ply 2x4 truss end vertical
 - 4x4 vertical web
 - Key-block

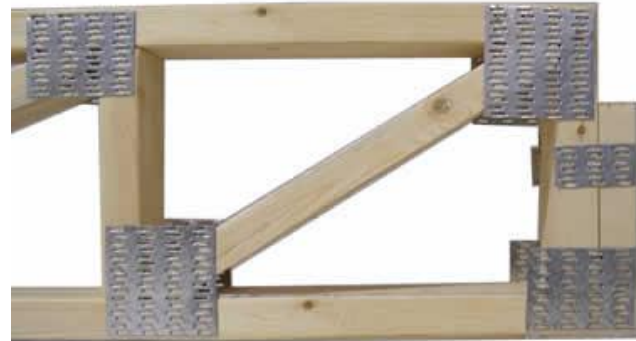

Step 2: Install Over Structural Sheathing

- Attach ledger with:
 - ½" x 6" lag screws or
 - ½"-diameter Standard Hex bolts with washers and nuts
 - Lag screws and bolts must meeting the requirements of ANSI/ASME Standard B18.2.1



Step 2: Install Over Structural Sheathing

- Maximum one fastener per truss member or key-block.
- Install fasteners through the centerline of the truss member or key-block
- Position fasteners to avoid interfering with bottom and top chord joints and connector plates.

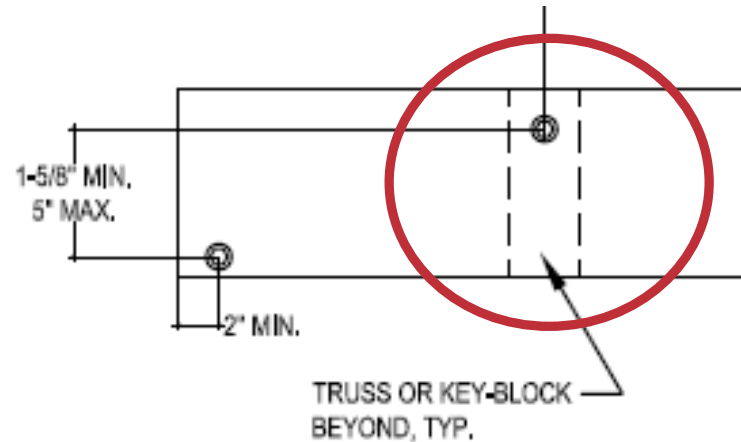

Step 3: Fastener Specification

- Lag screws and bolts must be installed according to 2015 NDS requirements.
- A "test" installation is recommended before drilling the lead holes, to ensure that the lead holes are neither too small nor too large.

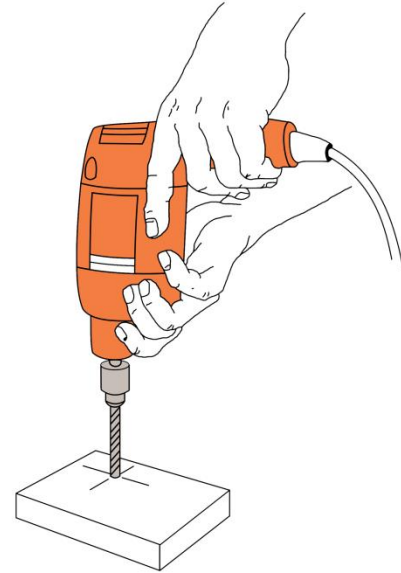

Step 3: Fastener Specification

- $\frac{1}{2}$ " x 6" lag screws:
 - Lead holes for the threaded portion must be $\frac{5}{16}$ ".
 - Clearance holes must be $\frac{1}{2}$ " and the same depth of penetration as the length of unthreaded shank.
- $\frac{1}{2}$ " diameter bolts:
 - Holes must be a minimum of $\frac{17}{32}$ " to a maximum of $\frac{9}{16}$ ".

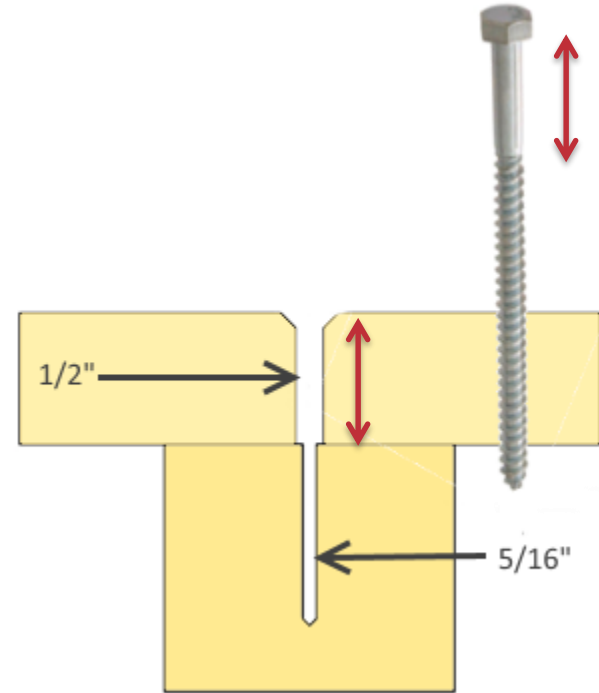

Step 3: Fastener Specification

- All fasteners used with PPT wood must be hot-dip zinc-coated including:
 - Galvanized steel
 - Stainless steel
 - Silicon bronze
 - Copper



Step 3: Fastener Specification

- Fasteners must meet [ASTM A153](#), Class D, for fasteners 3/8" diameter and smaller or Class C for fasteners with diameters over 3/8".
- Lag screws, bolts, nuts and washers are permitted to be mechanically deposited zinc-coated steel with coating weights in accordance with [ASTM B695](#), Class 55, minimum.



Step 4: Hardware Specification

- All hardware (e.g., joist hangers, hold-down device, etc.) must be galvanized or stainless steel.
 - Hardware hot-dipped prior to fabrication must meet [ASTM A653](#), G-185 coating.
 - Hardware hot-dipped post fabrication must meet [ASTM A123](#).



Step 4: Hardware Specification

- Additional requirements include:
 - Fasteners and hardware exposed to saltwater or located within 300' of a saltwater shoreline must be stainless steel grade 304 or 316.
 - Fasteners and hardware must be of the same corrosion-resistant material.
 - Other coated or non-ferrous fasteners or hardware must be approved by the authority having jurisdiction.

Step 5: Flashing Installation

- Install flashing at top of ledger for water tightness.
- Flashing must be corrosion-resistant metal of minimum nominal 0.019" thickness or an approved non-metallic material.
 - Do not use aluminum flashing in direct contact with lumber treated with preservatives containing copper, such as ACQ, Copper Azole or ACZA.



Step 6: Blocking

- Two-ply 2x4 truss end verticals, 4x4 truss vertical webs, and key-blocks connected to ledger with lag screws or bolts must have a specific gravity, $G \geq 0.42$ (includes DF, HF, SP and SPF).

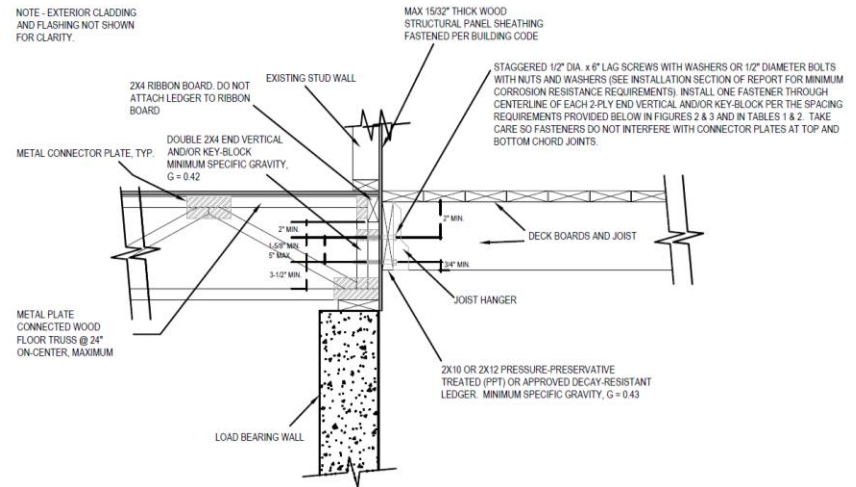

Step 6: Blocking

- Construct key-blocks with minimum 2x4 No. 2 or better lumber.
- Install key-blocks at required locations. Cut to fit tight.

KEY-BLOCK DETAIL FOR LEDGER ATTACHED TO END OF TRUSSES

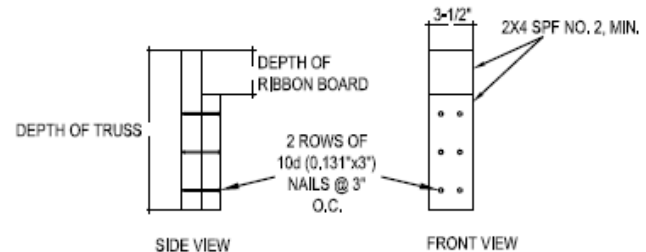

ATTACH TOP OF KEY-BLOCK TO INSIDE FACE OF RIBBON BOARD WITH 2 - 10d (0,131" x 3") THROUGH NAILS AND 2 - 10d TOE-NAILS. ATTACH BOTTOM OF KEY-BLOCK TO SILL PLATE WITH 4 - 10d TOE-NAILS

Step 7: Connect Joist to Lateral Load Connection

- Apply 24" long, full-height 7/16" 24/16 (min) span rated OSB or Plywood gusset to one side at end of truss.

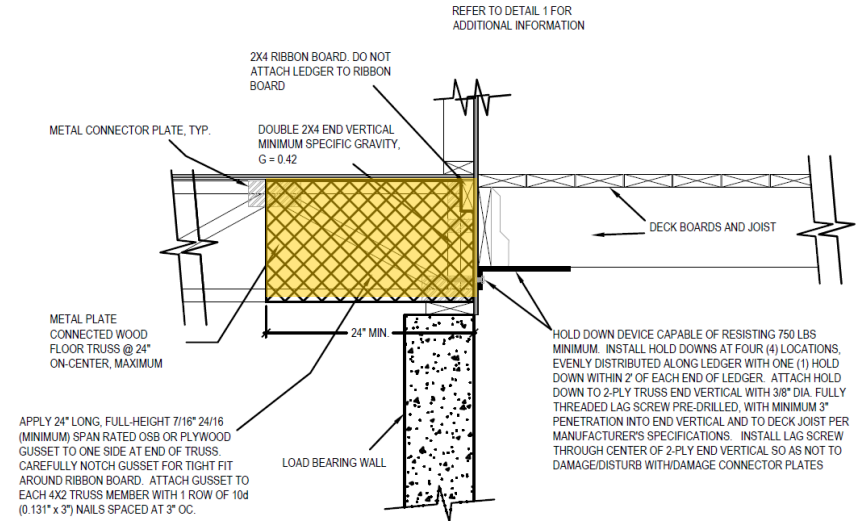

Step 7: Connect Joist to Lateral Load Connection

- Carefully notch gusset for tight fit around ribbon board.
- Attach to each 4x2 truss member with 1 row of 10d nails @ 3" o.c. per Figure 8.

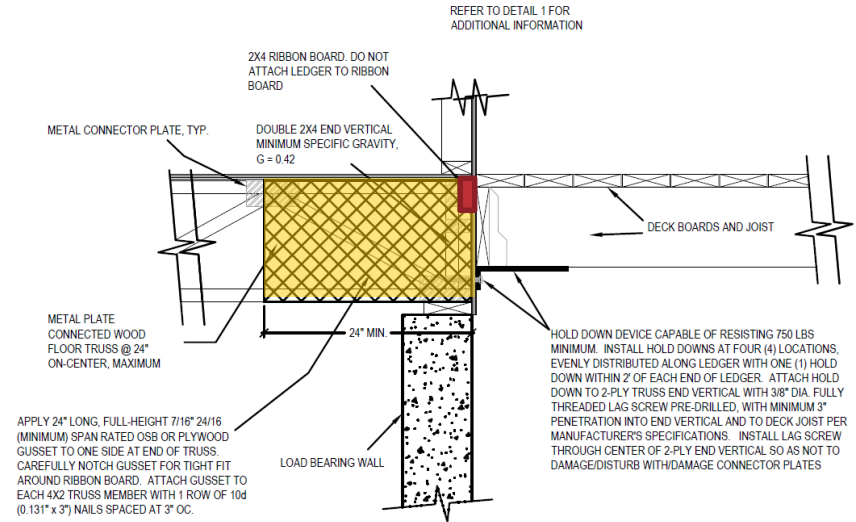

Step 7: Connect Joist to Lateral Load Connection

- Apply hold-down capable of resisting 750 lbs minimum.
- Install hold-downs at four (4) locations, evenly distributed along ledger with one (1) hold-down within 2' of each end of ledger.

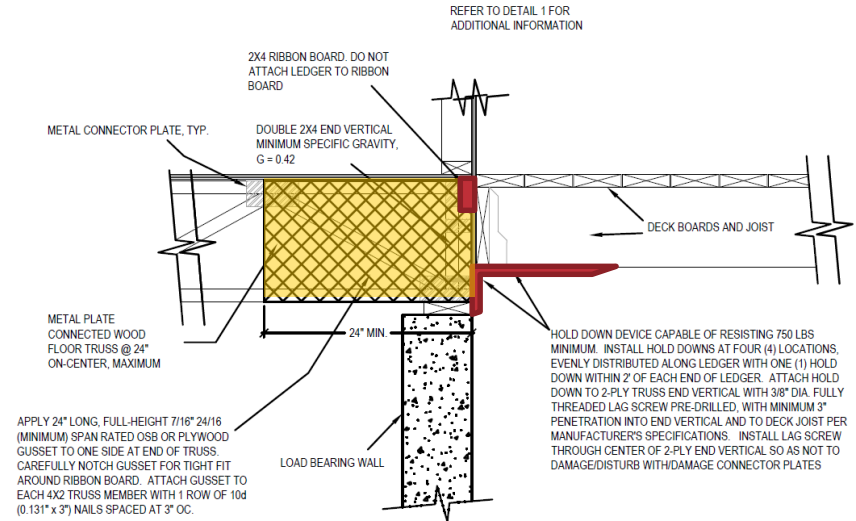

Step 7: Connect Joist to Lateral Load Connection

- Attach hold-down to truss end vertical with lag screw.
- Minimum 3" penetration into end vertical and to deck joist per manufacturer's specifications.

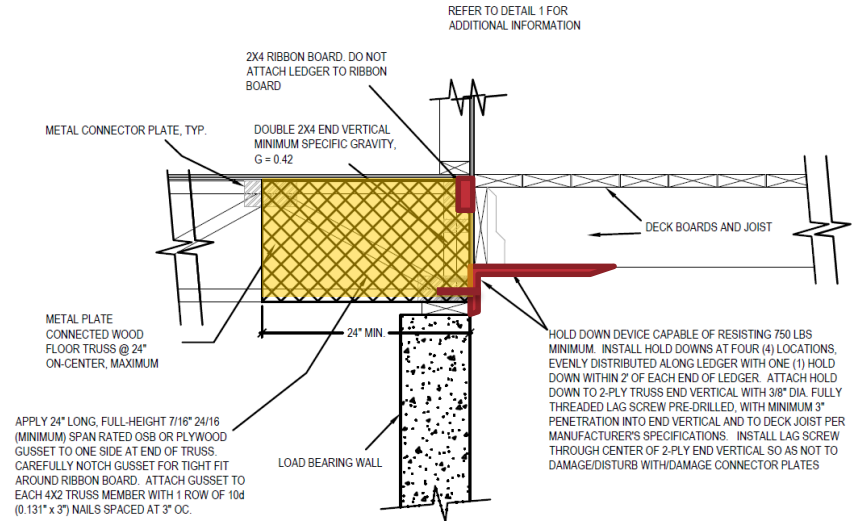

Step 7: Connect Joist to Lateral Load Connection

- Install lag screw through center of 2-ply end vertical so as not to damage or disturb connector plates.

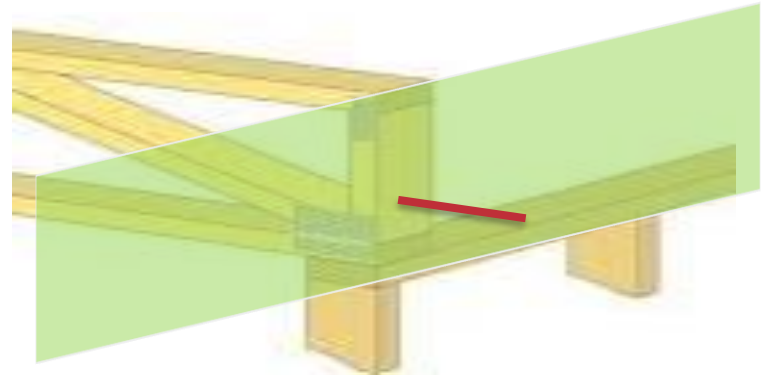

References

- [SRR 1408-01 - Attachment of Residential Deck Ledger to Metal Plate Connected Wood Truss Floor Systems](#)